

安徽神剑新材料股份有限公司

环境管理报告书



安徽神剑新材料股份有限公司

二零二一年三月



3

310

95

30.6%

2.1.2

72km

100km

30°38

31°31

117°58

118°43

4

5

1

1993

4

121.68

20

2600

500

26

93

78

13

2.1.3

90%
98%
1%
100%
24

2.2

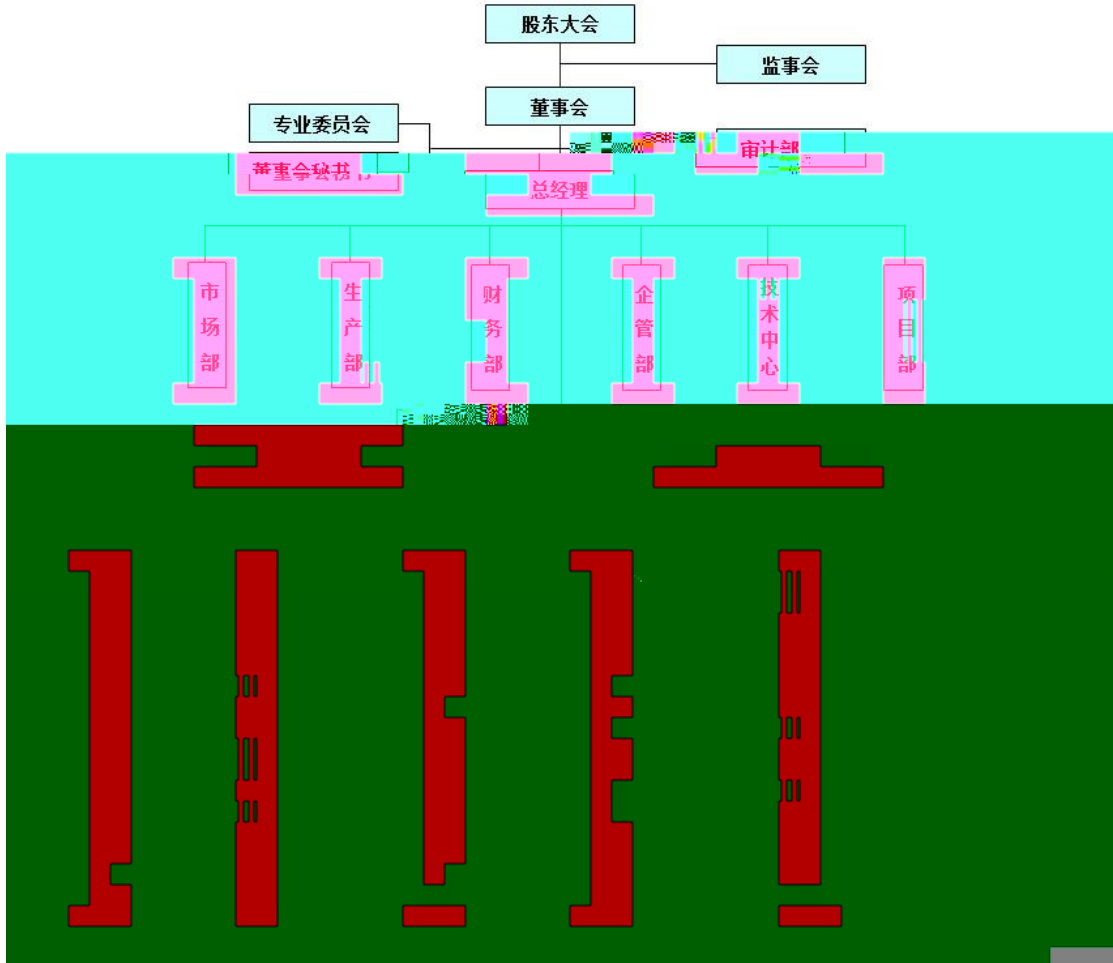

3.2

3.2.1

14

7

ISO14001

1

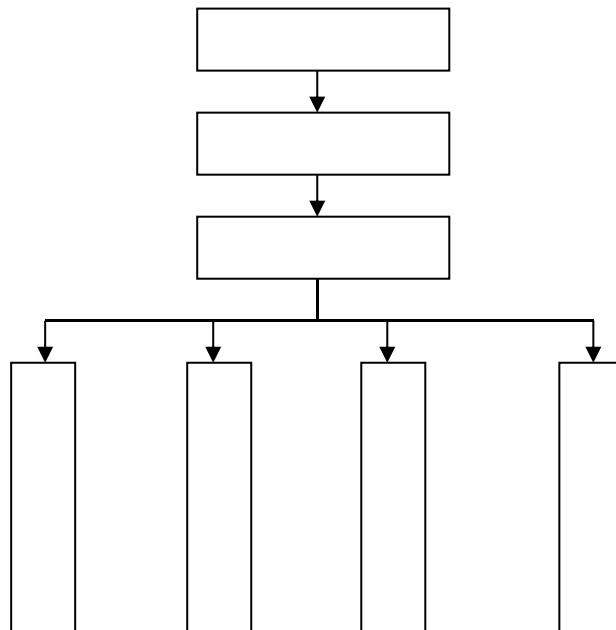

100%

3.3

3.4.1.2

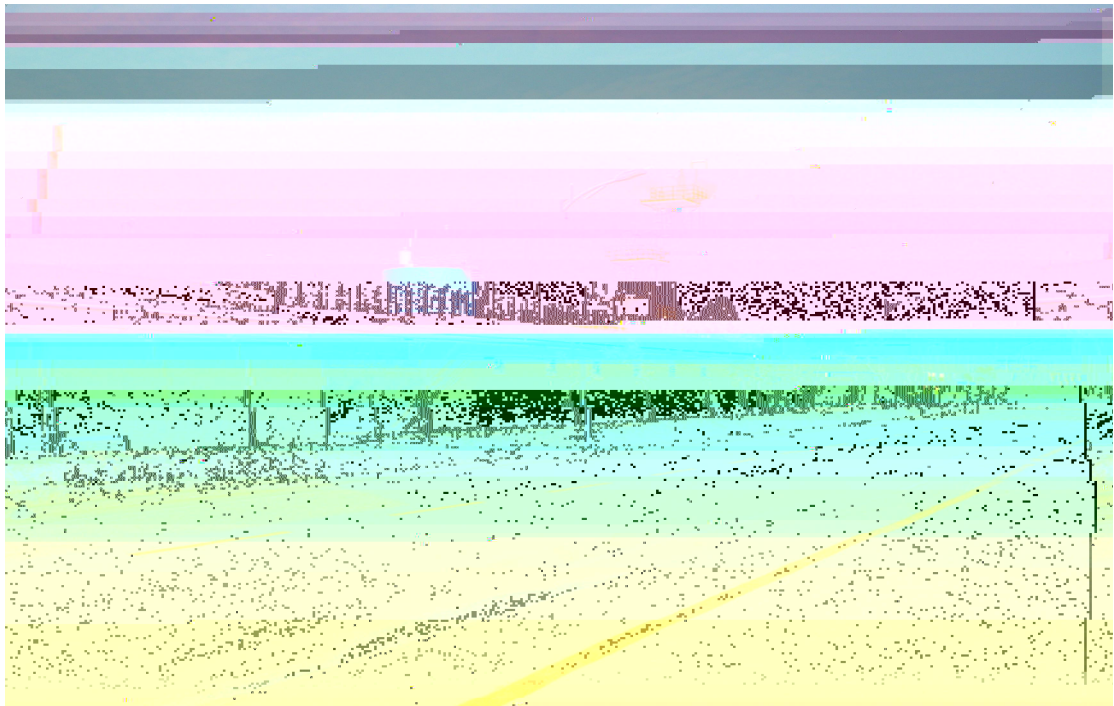
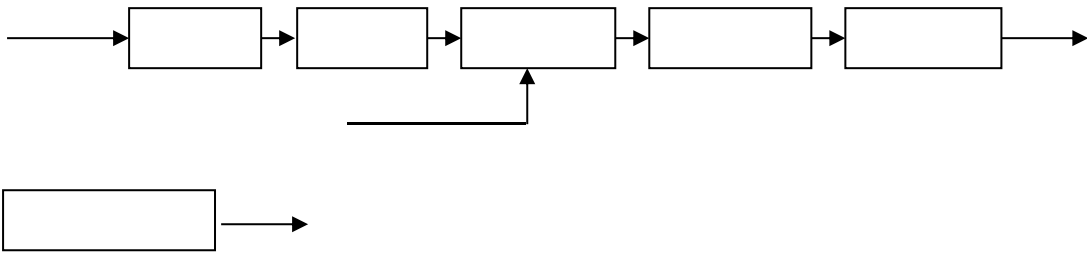

3.4.1.3

32544

COD

32.9mg/L

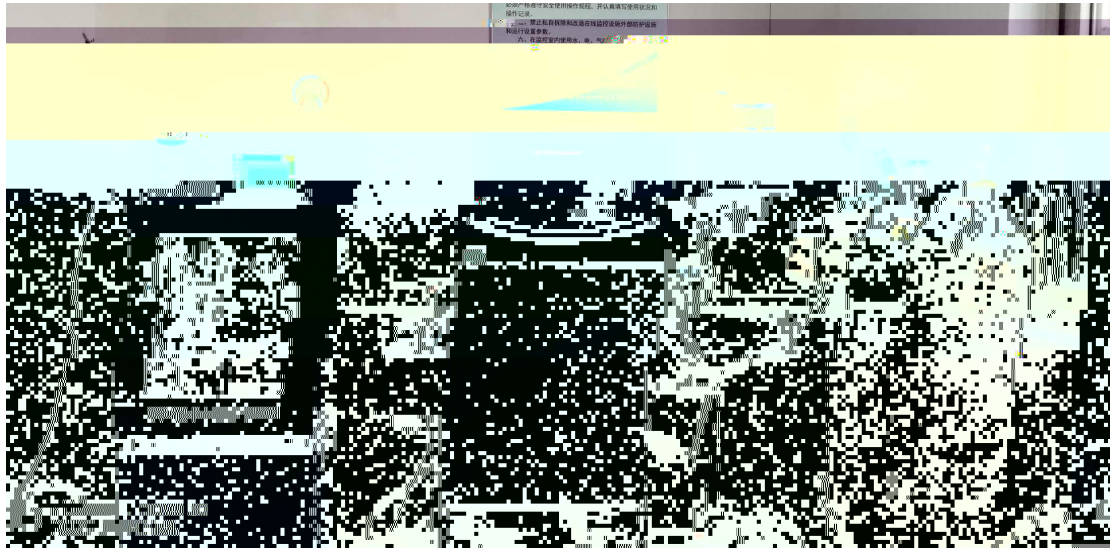

3.4.2

2-3 /

2-3 /

2-3 /

99.9%

+

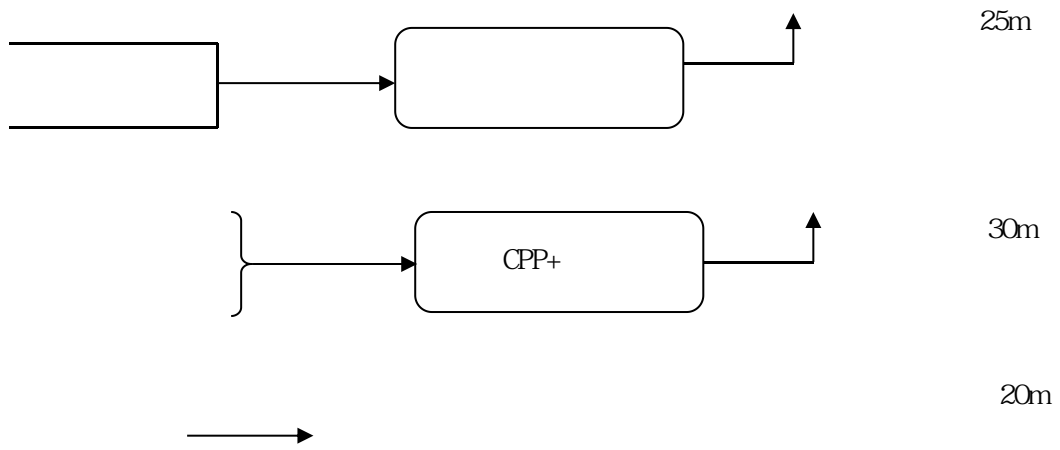



CPP+

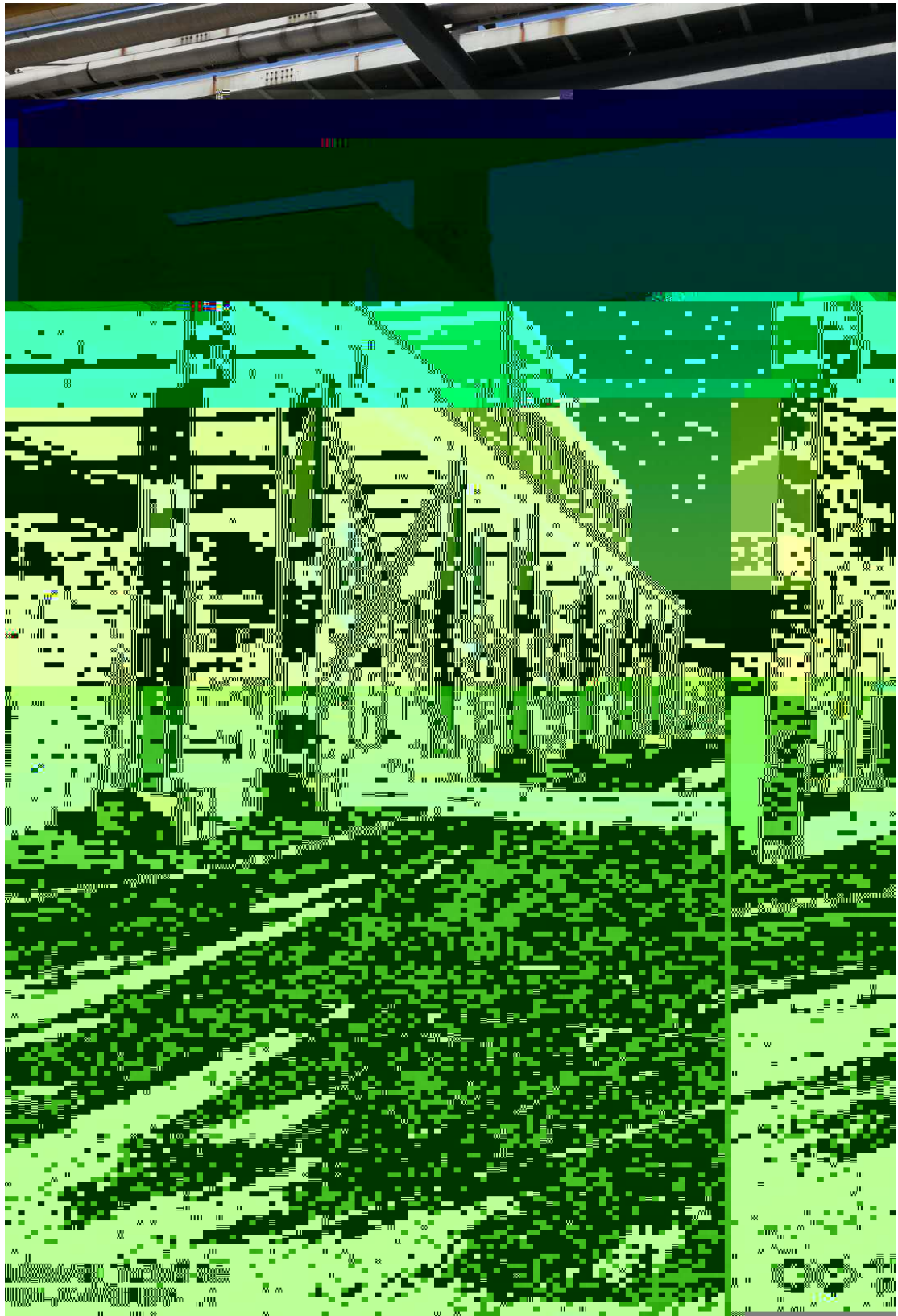

3.5

(2020)

	/	/		
	19.64	2	2020.12	
	19	1	2020.12	
	3	/	2020.12	
	27	1	2020.12	
	68.64			

3.6

3.7

4.1

4.2

4.2.1

GB 31572-2015

4.2.2

+

4.2.3

424

43

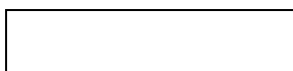

5.1

5.2 2020 1 1 2020 12 31

2021 3

5.3

0553-5316331

5.4

5.4.1 8

5.4.2

13866353177

0553-5316331-6077

0553-5316577